

AVH Half-brick Series

Technical Reference Notes

48V Input, 5V Single Output

50-150W DC-DC Converter

REV01



Introduction

The AVH series of switching DC-DC converters is one of the most cost effective options available in component power. The AVH uses an industry standard package size of **2.4"x2.28"x0.5"** and pinout configuration, provides standard control, trim, and sense functions, also features high power density up to **54.8W/in³** which gives more selectivity to meet small size requirement.

AVH series comes in 48V input version with a 2:1 (36-75V) input range. This series has input LVP, output OVP, OCP, short circuit protection and over temperature protection, and the isolation voltage is 1500Vdc. This series is designed to meet CISPR22, FCC class A, UL and CSA certifications.

The design features of the AVH series set a new standard for high density power converters. The unit employs an aluminum baseplate to carry all of the power components, and conduct the dissipated heat to the ambient. A conventional, multi-layer printed circuit board, over the top of the power substrate, contains all of the small signal control circuitry, all constructed with automated SMD technology.

Design Feature

- ☞ High Efficiency
- ☞ High power density
- ☞ Low output noise
- ☞ Metal baseplate
- ☞ CNT function
- ☞ Remote sense
- ☞ Trim function
- ☞ Input under-voltage lockout
- ☞ Output short circuit protection
- ☞ Output current limiting
- ☞ Output over-voltage protection
- ☞ Overtemperature protection
- ☞ High input-output isolation voltage

Options

- ☞ Heat sink available for extended operation.
- ☞ Choice of CNT logic configuration.

Note

Ionom is rated output current in this manual.

Vonom is rated output voltage in this manual.

Typical Application

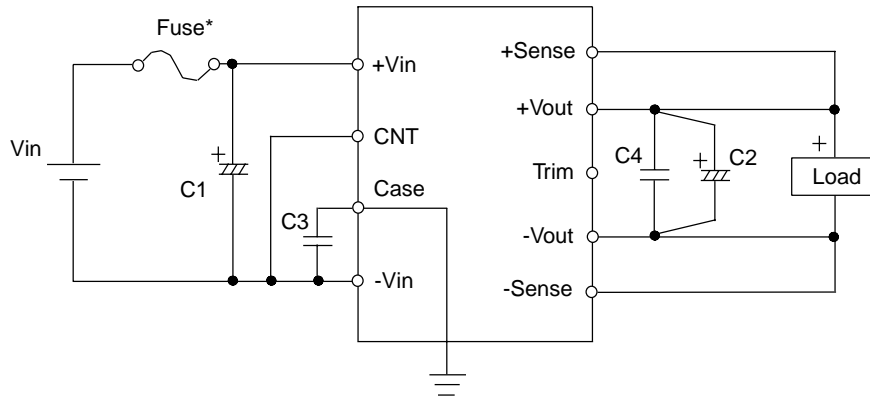

Fuse*: Use external fuse (fast blow type) for each unit.

50W output : 5A fuse

75W output : 7.5A fuse

100W output : 10A fuse

150W output : 20A fuse

C1: Recommended input capacitor C1

-5 °C ~ +100 °C : $\geq 100\mu\text{F}/100\text{V}$ electrolytic or ceramic type capacitor.

-40 °C ~ +100 °C : $\geq 100\mu\text{F}/100\text{V}$ ceramic type capacitor only.

C2: Recommended output capacitor C2

-5 °C ~ +100 °C : 1000 $\mu\text{F}/16\text{V}$ (electrolytic capacitor) for 50W-75W

2200 $\mu\text{F}/16\text{V}$ (electrolytic capacitor) for 100W-150W

-40 °C ~ +100 °C : For this temperature range, use two pieces of the recommended capacitor above.

C3: Recommended 4700pF/2000V

C4: Recommended 0.1 $\mu\text{F}/10\text{V}$

AVH Half-Brick Series
48V Input, 5V Single Output, 50-150W DC-DC Converter

Block Diagram

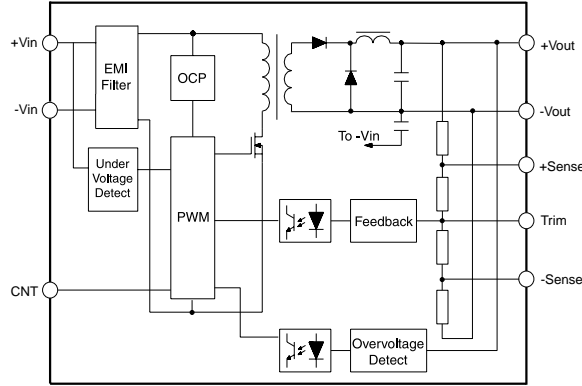

Model Numbering

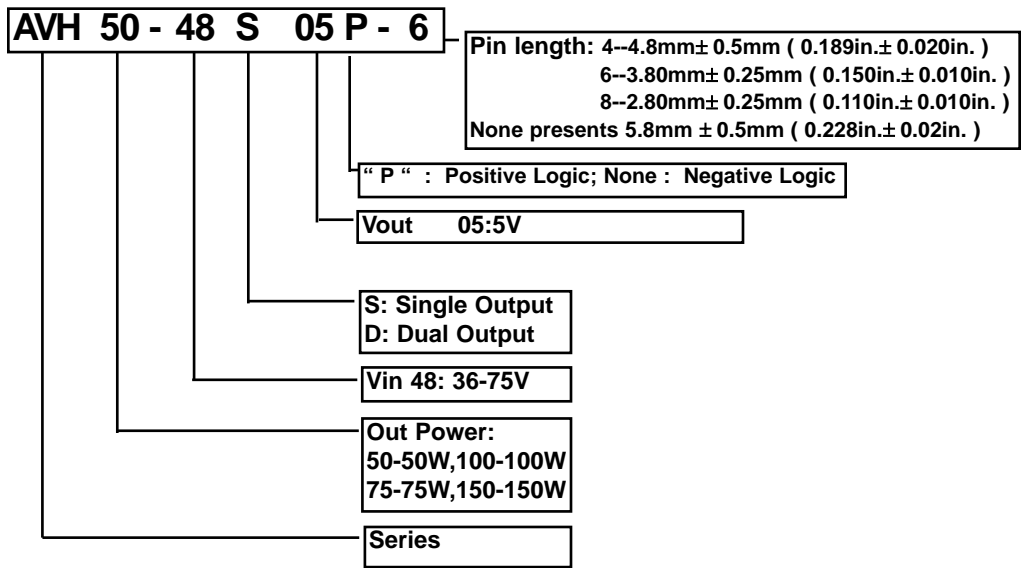

Ordering Information

Model Number	Input Voltage	Output Voltage	Output Current	Ripple (mV rms)	Noise (mV pp)	Efficiency	
						min	typ
AVH50-48S05(P)	36-75V	5V	10A	40	150	83%	84%
AVH75-48S05(P)	36-75V	5V	15A	40	150	83%	85%
AVH100-48S05(P)	36-75V	5V	20A	40	150	83%	85%
AVH150-48S05(P)	36-75V	5V	30A	40	150	83%	85%

AVH Half-Brick Series
48V Input, 5V Single Output, 50-150W DC-DC Converter

Absolute Maximum Rating

Characteristic	Min	Typ	Max	Units	Notes
Input Voltage(continuous)	-0.3		80	Vdc	100ms non-repetitive
Input Voltage(peak/surge)	-0.3		100	Vdc	
base-plate temperature	-40		100	°C	
storage temperature	-55		125	°C	

Input Characteristics

Characteristic	Min	Typ	Max	Units	Notes
Input Voltage Range	36	48	75	Vdc	
Input Reflected Current		30	150	mAp-p	
Turn-off Input Voltage	30	33	35	V	
Turn-on Input Voltage	31	34	36	V	
Turn On Time		20	35	ms	

CNT Function

Characteristic	Min	Typ	Max	Units	Notes
Logic High	3.5		15	Vdc	
Logic Low	-0.7		1.2	Vdc	
Control Current			2	mA	

General Specifications

Characteristic	Min	Typ	Max	Units	Notes
MTBF	2000			k Hrs	Bellcore TR332, Tc=25°C
Isolation	1500			Vdc	
Pin solder temperature			260	°C	wave solder < 10 s
Hand Soldering Time			5	s	iron temperature 425°C
Weight		75		grams	

AVH Half-Brick Series
48V Input, 5V Single Output, 50-150W DC-DC Converter

AVH50-48S05(P) Output Characteristics

Characteristic	Min	Typ	Max	Units	Notes
Power			50	W	
Output Current	1		10	A	
Output Setpoint Voltage	4.95	5	5.05	Vdc	Vin=48V, Io=10A
Line Regulation		0.02	0.2	%Vonom	Vin=36~75V, Io=10A
Load Regulation		0.1	0.5	%Vo nom	Io=0~10A, Vin=48V
Dynamic Response					
50-75% load		2.5	5	%Vonom	Ta=25°C, di/dt=1A/10µs
		100	300	µs	Ta=25°C, DI/Dt=1A/10µs
50-25% load		2.5	5	%Vonom	Ta=25°C, DI/Dt=1A/10µs
		100	300	µs	Ta=25°C, DI/Dt=1A/10µs
Current Limit Threshold	11	13	14	A	
Short Circuit Current		17		A	
Efficiency	83	84		%	Vin=48V, Io=10A
Trim Range	-10		+10	%Vonom	
Over Voltage Protection Setpoint	5.75		7	V	
Sense Compensation			0.5	V	
Temperature Regulation			0.02	%Vonom/°C	
Ripple (rms)		20	40	mV	20MHz Bandwidth
Noise (p-p)		100	150	mV	20MHz Bandwidth
Over Temperature Protection	102	105	115	°C	
Switching Frequency		300		kHz	
Maximum Capacitor Load			10000	µF	

AVH Half-Brick Series
48V Input, 5V Single Output, 50-150W DC-DC Converter

AVH75-48S05(P) Output Characteristics

Characteristic	Min	Typ	Max	Units	Notes
Power			75	W	
Output Current	1.5		15	A	
Output Setpoint Voltage	4.95	5	5.05	Vdc	Vin=48V, Io=15A
Line Regulation		0.02	0.2	%Vonom	Vin=36~75V, Io=15A
Load Regulation		0.1	0.5	%Vonom	Io=0~15A, Vin=48V
Dynamic Response					
50-75% load		2.5	5	%Vonom	Ta=25°C, di/dt=1A/10µs
		100	300	µs	Ta=25°C, DI/Dt=1A/10µs
50-25% load		2.5	5	%Vonom	Ta=25°C, DI/Dt=1A/10µs
		100	300	µs	Ta=25°C, DI/Dt=1A/10µs
Current Limit Threshold	16.5	19	21	A	
Short Circuit Current		25		A	
Efficiency	83	85		%	Vin=48V, Io=15A
Trim Range	-10		+10	%Vonom	
Over Voltage Protection Setpoint	5.75		7	V	
Sense Compensation			0.5	V	
Temperature Regulation			0.02	%Vonom/°C	
Ripple (rms)		20	40	mV	20MHz Bandwidth
Noise (p-p)		100	150	mV	20MHz Bandwidth
Over Temperature Protection	102	105	115	°C	
Switching Frequency		300		kHz	
Maximum Capacitor Load			10000	µF	

AVH Half-Brick Series
48V Input, 5V Single Output, 50-150W DC-DC Converter

AVH100-48S05(P) Output Characteristics

Characteristic	Min	Typ	Max	Units	Notes
Power			100	W	
Output Current	2		20	A	
Output Setpoint Voltage	4.95	5	5.05	Vdc	Vin=48V, Io=20A
Line Regulation		0.02	0.2	%Vonom	Vin=36~75V, Io=20A
Load Regulation		0.1	0.5	%Vonom	Io=0~20A, Vin=48V
Dynamic Response					
50-75% load		2.5	5	%Vonom	Ta=25°C, di/dt=1A/10µs
		100	300	µs	Ta=25°C, DI/Dt=1A/10µs
50-25% load		2.5	5	%Vonom	Ta=25°C, DI/Dt=1A/10µs
		100	300	µs	Ta=25°C, DI/Dt=1A/10µs
Current Limit Threshold	22	25	28	A	
Short Circuit Current		34		A	
Efficiency	83	85		%	Vin=48V, Io=20A
Trim Range	-10		+10	%Vonom	
Over Voltage Protection Setpoint	5.75		7	V	
Sense Compensation			0.5	V	
Temperature Regulation			0.02	%Vonom/°C	
Ripple (rms)		20	40	mV	20MHz Bandwidth
Noise (pp)		100	150	mV	20MHz Bandwidth
Over Temperature Protection	102	105	115	°C	
Switching Frequency		300		kHz	
Maximum Capacitor Load			10000	µF	

AVH Half-Brick Series
48V Input, 5V Single Output, 50-150W DC-DC Converter

AVH150-48S05(P) Output Characteristics

Characteristic	Min	Typ	Max	Units	Notes
Power			150	W	
Output Current	3		30	A	
Output Setpoint Voltage	4.95	5	5.05	Vdc	Vin=48V, Io=30A
Line Regulation		0.02	0.2	%Vonom	Vin=36~75V, Io=30A
Load Regulation		0.1	0.5	%Vonom	Io=0~30A, Vin=48V
Dynamic Response					
50-75% load		2.5	5	%Vonom	Ta=25°C, di/dt=1A/10µs
		100	300	µs	Ta=25°C, DI/Dt=1A/10µs
50-25% load		2.5	5	%Vonom	Ta=25°C, DI/Dt=1A/10µs
		100	300	µs	Ta=25°C, DI/Dt=1A/10µs
Current Limit Threshold	32	36	40	A	
Short Circuit Current		50		A	
Efficiency	83	85		%	Vin=48V, Io=30A
Trim Range	-10		+10	%Vonom	
Over Voltage Protection Setpoint	5.75		7	V	
Sense Compensation			0.5	V	
Temperature Regulation			0.02	%Vonom/°C	
Ripple (rms)		20	40	mV	20MHz Bandwidth
Noise (pp)		100	150	mV	20MHz Bandwidth
Over Temperature Protection	102	105	115	°C	
Switching Frequency		300		kHz	
Maximum Capacitor Load			10000	µF	

Efficiency Characteristic Curves (at 25 °C)

Typical Efficiency AVH50-48S05

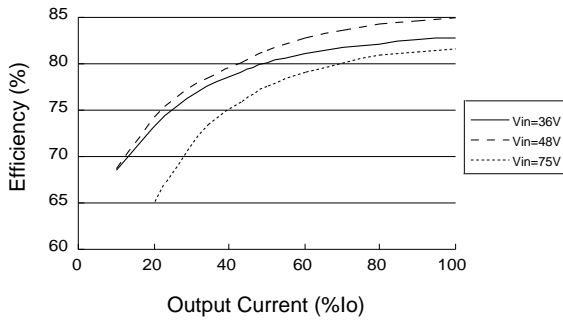

Typical Efficiency AVH75-48S05

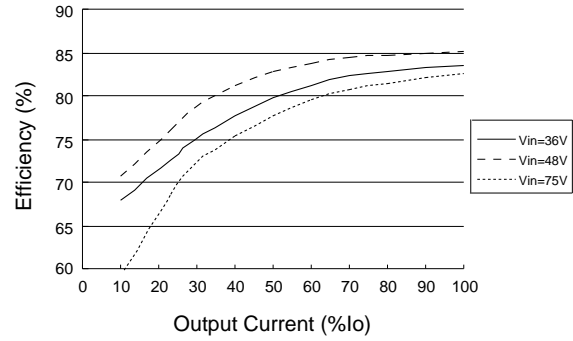

Typical Efficiency AVH100-48S05

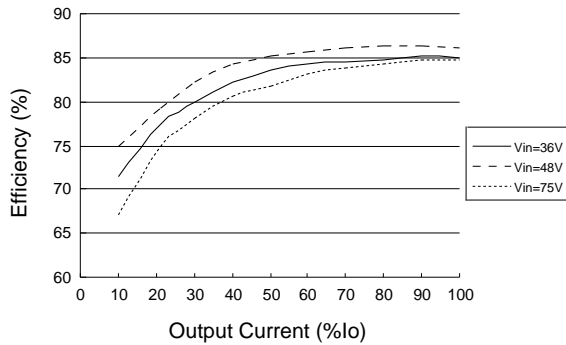

Typical Efficiency AVH150-48S05

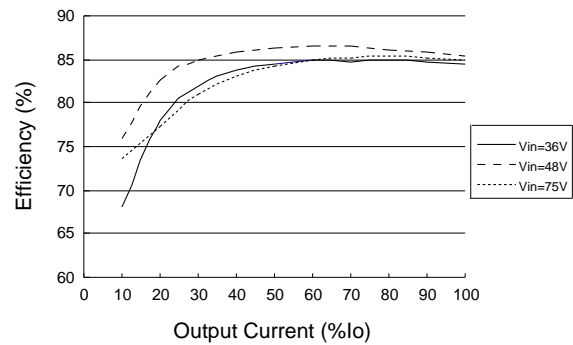

Overcurrent Protection (OCP)(at 25 °C)

Typical Output Overcurrent Performance
AVH50-48S05

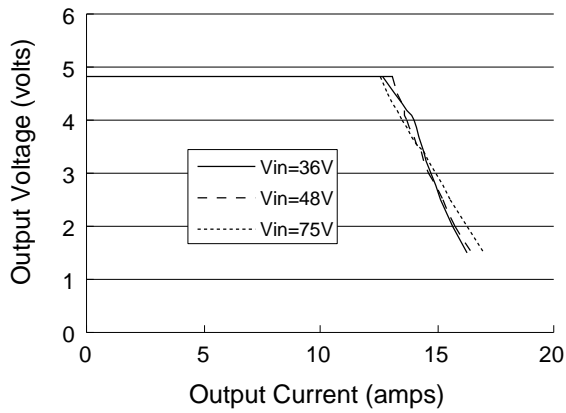

Typical Output Overcurrent Performance
AVH75-48S05

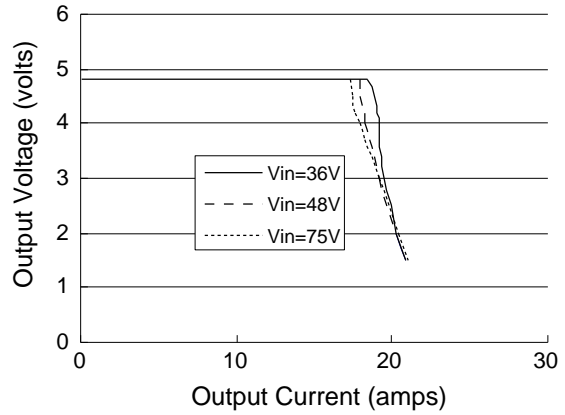

Typical Output Overcurrent Performance
AVH100-48S05

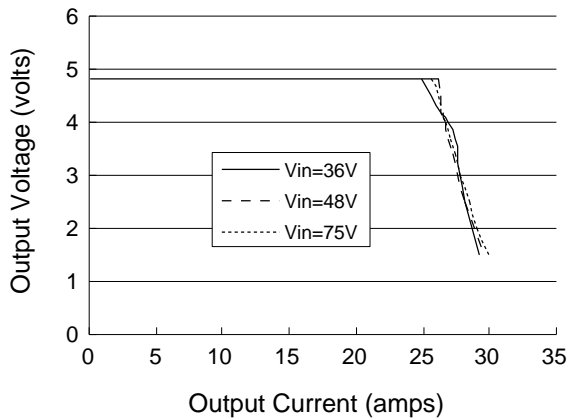

Typical Output Overcurrent Performance
AVH150-48S05

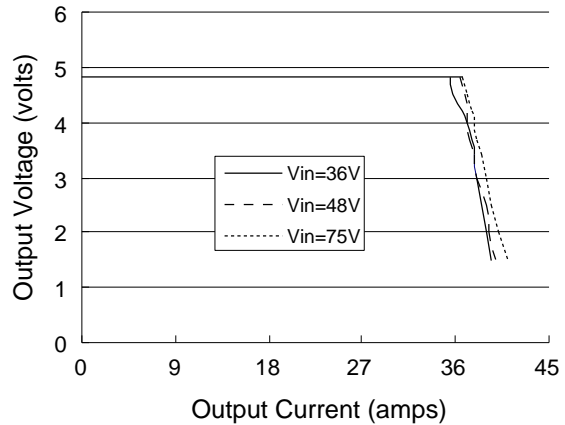

Transient response (at 25 °C)

**Typical Transient Response Load Increased
 from 50%I_{omax} to 75%I_{omax}
 AVH150-48S05**

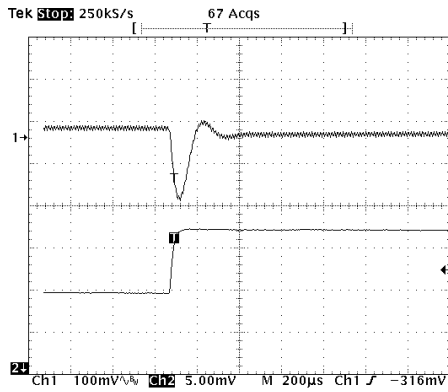

**Typical Transient Response Load Decreased
 from 50%I_{omax} to 25%I_{omax}
 AVH150-48S05**

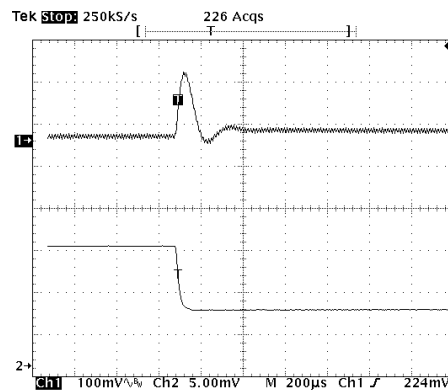

**Typical Start-Up from CNT Control
 AVH150-48S05**

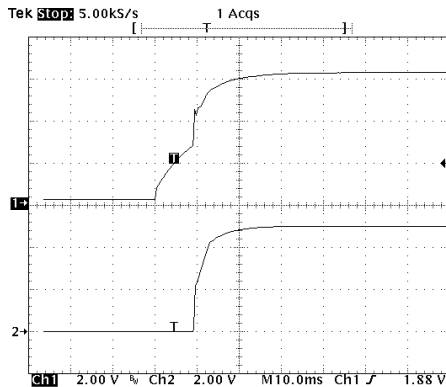

**Typical Shut-down from CNT Control
 AVH150-48S05**

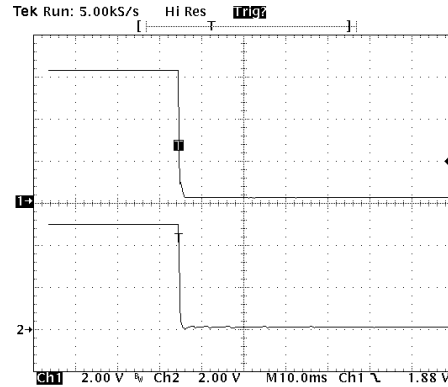

Typical Output Voltage Start-up From Power On

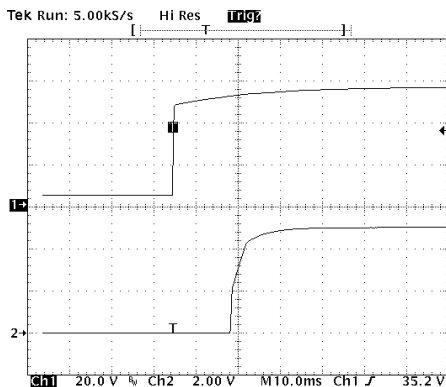

Typical Input Current AVH150-48S05

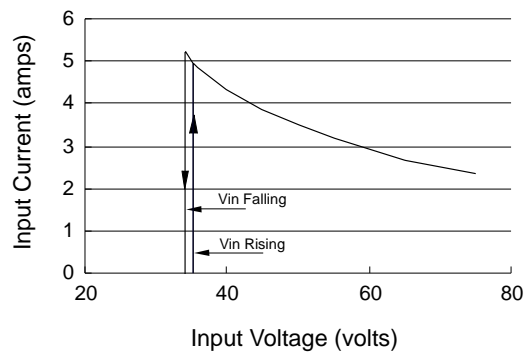

Pins

The +Vin and -Vin input connection pins are located as shown in Figure 1. AVH converters have a 2:1 input voltage range and 48 Vin converters can accept 36-75 Vdc. Care should be taken to avoid applying reverse polarity to the input which can damage the converter.

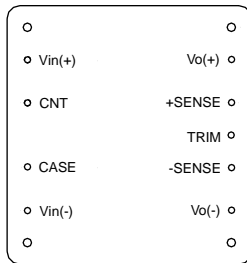

Fig.1 Pin Location (Base-plate Side View)

Input Characteristic

Fusing

The AVH power module has no internal fuse. **An external fuse must always be employed!** To meet international safety requirements, a 250 Volt rated fuse should be used. If one of the input lines is connected to chassis ground, then the fuse must be placed in the other input line. Standard safety agency regulations require input fusing. Recommended fuse ratings for the AVH Series are shown in Table 1.

Table 1

Series	Fuse Rating(48Vin)
AVH50	5A
AVH75	7.5A
AVH100	10A
AVH150	20A

Input Reverse Voltage Protection

Under installation and cabling conditions where reverse polarity across the input may occur, reverse polarity protection is recommended. Protection can easily be provided as shown in Figure 2. In both cases the diode rating is determined by the power of the converter. Diodes should be rated at 20A/100V for AVH150-48's, 10A/100V for AVH100-48's, 7.5A/100V for AVH75-48's, and 5A/100V for AVH50-48's.

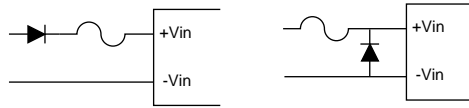

Fig.2 Reverse Polarity Protection Circuits

Placing the diode across the inputs rather than in-line with the input offers an advantage in that the diode only conducts in a reverse polarity condition, which increases circuit efficiency and thermal performance.

Input Undervoltage Protection

The AVH is protected against undervoltage on the input. If the input voltage drops below the acceptable range, the converter will shut down. It will automatically restart when the undervoltage condition is removed.

Input Filter

Input filters are included in the converters to help achieve standard system emissions certifications. Some users however, may find that additional input filtering is necessary. The AVH series has an internal switching frequency of 300 kHz so a high frequency capacitor mounted close to the input terminals produces the best results. To reduce reflected noise, a capacitor can be added across the input as shown in Figure 3, forming a π filter. A

47 μ F/100V electrolytic capacitor is recommended for C1.

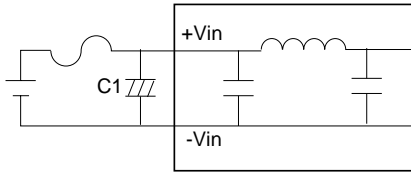

Fig.3 Ripple Rejection Input Filter

For conditions where EMI is a concern, a different input filter can be used. Figure 4 shows an input filter designed to reduce EMI effects. L1 is a 5mH common mode choke.

When a filter inductor is connected in series with the power converter input, an input capacitor C1 should be added. An input capacitor C1 should also be used when the input wiring is long, since the wiring can act as an inductor.

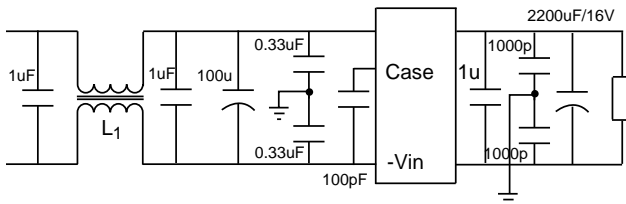

Fig.4 EMI Reduction Input Filter

Failure to use an input capacitor under these conditions can produce large input voltage spikes and an unstable output. spikes and an unstable output.

CNT Function

Two CNT options are available.

Negative logic applying a voltage less than 1.2V to the CNT pin will enable the output, and applying a voltage greater than 3.5V will disable it.

Positive logic applying a voltage larger than 3.5V to the CNT pin will enable the output, and applying a voltage less than 1.2V will disable it.

Positive logic, device code suffix “ P “. Negative logic, device code suffix nothing is the factory-preferred.

If the CNT pin is left open, the converter will default to “ control off ” operation in negative logic, but default to “ control on ” in positive logic.

The maximum voltage that can be applied to the CNT pin is 15V.

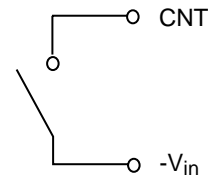

Fig.5 Simple Control

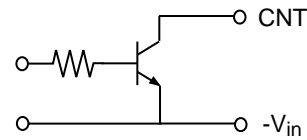

Fig.6 Transistor Control

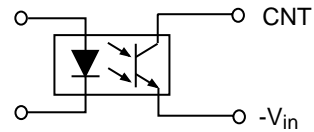

Fig.7 Isolated Control

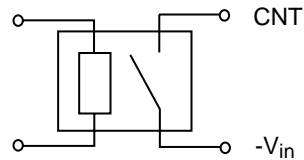

Fig.8 Relay Control

Input-Output Characteristic

Safety Consideration

For safety-agency approval of the system in which the power module is used, the power module must be installed in compliance with the spacing and separation requirements of the end-use safety agency standard, i.e., UL1950, CSA C22.2 No. 950-95, and EN60950.

The input-to-output 1500VDC isolation is an operational insulation. The DC/DC power module should be installed in end-use equipment, in compliance with the requirements of the ultimate application, and is intended to be supplied by an isolated secondary circuit.

When the supply to the DC/DC power module meets all the requirements for SELV(<60Vdc), the output is considered to remain within SELV limits (level 3). If connected to a 60Vdc power system, double or reinforced insulation must be provided in the power supply that isolates the input from any hazardous voltages, including the ac mains. One Vi pin and one Vo pin are to be grounded or both the input and output pins are to be kept floating. Single fault testing in the power supply must be performed in combination with the DC/DC power module to demonstrate that the output meets the requirement for SELV. The input pins of the module are not operator accessible.

Note: Do not ground either of the input pins of the module, without grounding one of the output pins. This may allow a non-SELV voltage to appear between the output pin and ground.

Case Grounding

For proper operation of the module, the case or baseplate of the AVH module does not require

a connection to a chassis ground. Whether to ground the case must be decided by safety considerations, and entirely determined by the final application. If the AVH module is not in a metallic enclosure in a system, it may be advisable to directly ground the case to reduce electric field emissions. Leaving the case floating can help to reduce magnetic field radiation from common mode noise currents. If the case has to be grounded for safety or other reasons, an inductor can be connected to chassis at DC and AC line frequencies, but be left floating at switching frequencies. Under this condition, the safety requirements are met and the emissions are minimized. In general, the inductor maintains a DC resistance from the case to chassis ground of no more than 0.1 S during the safely conducting of all the available input current. All the available input current refer to the value of the input fuse to the module. IEC 950 requires testing the DC resistance at 1.5 times that value. Specific safety requirements may dictate something different.

Output Characteristics

Minimum Load Requirement

The AVH series modules will maintain regulation and operate properly with a NO LOAD condition. However, the transient response is altered below a minimum output load condition. When the module is operating below the minimum load, the transient amplitude and recovery time are both increased when the load is stepped higher, the output ripple continues to meet the peak to peak requirements. For the AVH modules, the 10% minimum load require-

ment is strictly in order to meet all performance specifications.

Remote Sensing

The AVH converter can remotely sense both lines of its output which moves the effective output voltage regulation point from the output of the unit to the point of connection of the remote sense pins. This feature automatically adjusts the real output voltage of the AVH in order to compensate for voltage drops in distribution and maintain a regulated voltage at the point of load.

When the converter is supporting loads far away, or is used with undersized cabling, significant voltage drop can occur at the load. The best defense against such drops is to locate the load close to the converter and to ensure adequately sized cabling is used. When this is not possible, the converter can compensate for a drop of up to 10% V_{onom} through use of the sense leads.

When used, the + and - Sense leads should be connected from the converter to the point of load as shown in Figure 9 using twisted pair wire. The converter will then regulate its output voltage at the point where the leads are connected. Care should be taken not to reverse the sense leads. If reversed, the converter will trig-

ger OVP protection and turn off. When not used, the +Sense lead must be connected with +Vo, and -Sense with -Vo. Also note that the output voltage and the remote sense voltage offset must be less than the minimum overvoltage trip point.

Note that at elevated output voltages the maximum power rating of the module remains the same, and the output current capability will decrease correspondingly.

Output Trimming

Users can increase or decrease the output voltage set point of a module by connecting an external resistor between the TRIM pin and either the SENSE (+) or SENSE (-) pins. The trim resistor should be positioned close to the module.

If not using the trim feature, leave the TRIM pin open.

Trimming up by more than 10% of the nominal output may damage the converter. Trimming down more than 10% can cause the converter to regulate improperly. Trim down and trim up circuits and the corresponding configuration are shown in Figure 10 and Figure 11.

Note that at elevated output voltages the maximum power rating of the module remains the same, and the output current capability will decrease correspondingly.

The circuits and test results for the trim up and trim down configurations are displayed as following:

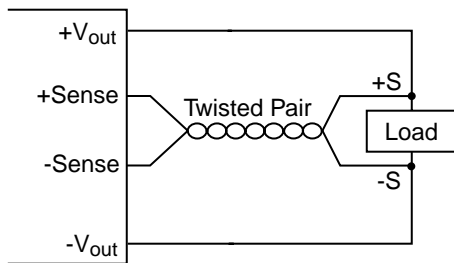
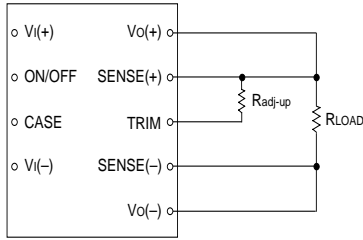

Fig.9 Sense Connections

AVH Half-Brick Series
48V Input, 5V Single Output, 50-150W DC-DC Converter



$$R_{\text{adj-up}} = \frac{V_o(100+y)}{1.26y} - \frac{(100+2y)}{y}$$

where y is the adjusting percentage of the voltage.
 $0 < y < 10$
 $R_{\text{adj-up}}$ is in $k\Omega$.

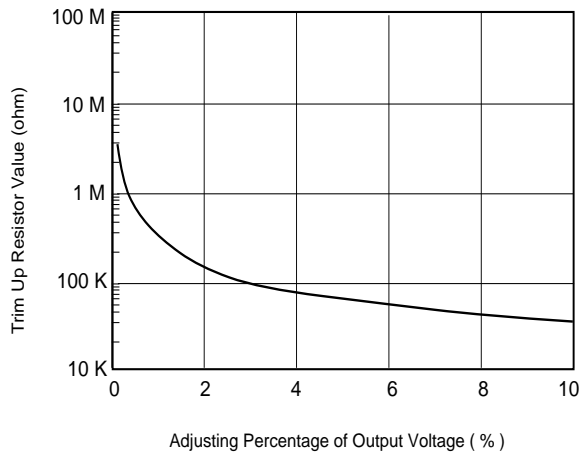
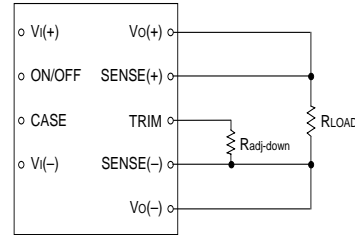

Fig.10 Trim Up Circuit and Curves



$$R_{\text{adj-down}} = \frac{100}{y} - 2$$

where y is the adjusting percentage of the voltage.
 $0 < y < 10$
 $R_{\text{adj-down}}$ is in $k\Omega$.

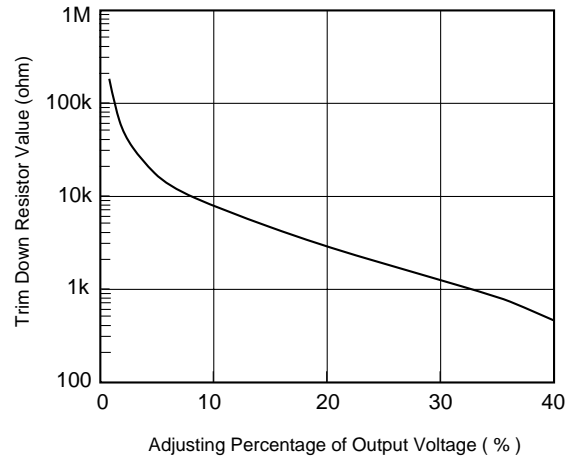

Fig.11 Trimming Down Circuit and Curves

Output Over-Voltage Protection

The over-voltage protection has a separate feedback loop which activates when the output voltage is between 5.75V-7V. When an over-voltage condition occurs, a “ turn off “ signal was sent to the input of the module, and shut off the output. The module will restart after power on again.

Output Over-Current Protection

AVH series DC/DC converters feature foldback current limiting as part of their Overcurrent Protection (OCP) circuits. When output current exceeds 110 to 140% of rated current, such as during a short circuit condition, the output will shutdown immediately, and can tolerate short circuit conditions indefinitely. When the over-current condition is removed, the converter will automatically restart.

Output Filters

When the load is sensitive to ripple and noise, an output filter can be added to minimize the effects. A simple output filter to reduce output ripple and noise can be made by connecting a capacitor across the output as shown in Figure 12. The recommended value for the output capacitor is 2200 μ F/10V.

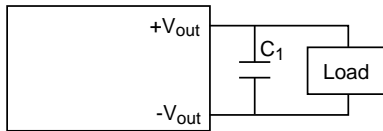

Fig.12 Output Ripple Filter

Extra care should be taken when long leads or traces are used to provide power to the load. Long lead lengths increase the chance for noise to appear on the lines. Under these conditions C2 can be added across the load as shown in Figure 13. The recommended component for C2 is 2200 μ F/10V capacitor and connecting a 0.1 μ F ceramic capacitor in parallel generally.

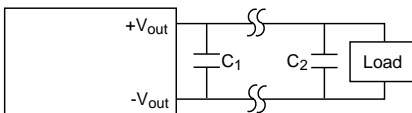

Fig.13 Output Ripple Filter For a Distant Load

Decoupling

Noise on the power distribution system is not always created by the converter. High speed analog or digital loads with dynamic power demands can cause noise to cross the power inductor back onto the input lines. Noise can be reduced by decoupling the load. In most cases, connecting a 10 μ F tantalum capacitor in parallel with a 0.1 μ F ceramic capacitor across the load will decouple it. The capacitors should be connected as close to the load as possible.

Ground Loops

Ground loops occur when different circuits are given multiple paths to common or earth ground, as shown in Figure 14. Multiple ground points can slightly different potential and cause current flow through the circuit from one point to another. This can result in additional noise in all the circuits. To eliminate the problem, circuits should be designed with a single ground connection as shown in Figure 15.

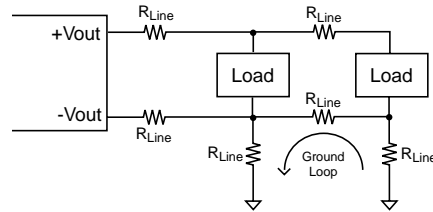

Fig.14 Ground Loops

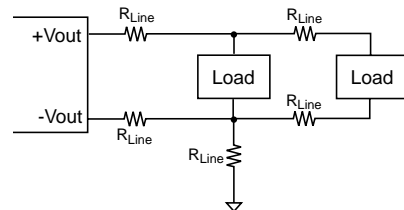

Fig.15 Single Point Ground

Parallel Power Distribution

Figure 16 shows a typical parallel power distribution design. Such designs, sometimes called daisy chains, can be used for very low output currents, but are not normally recommended. The voltage across loads far from the source can vary greatly depending on the IR drops along the leads and changes in the loads closer to the source. Dynamic load conditions increase the potential problems.

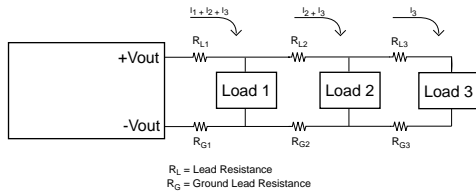

Fig.16 Parallel Power Distribution

Radial Power Distribution

Radial power distribution is the preferred method of providing power to the load. Figure 17 shows how individual loads are connected directly to the power source. This arrangement requires additional power leads, but it avoids the voltage variation problems associated with the parallel power distribution technique.

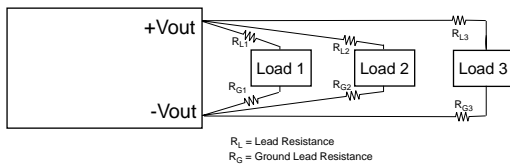

Fig.17 Radial Power Distribution

Mixed Distribution

In the real world a combination of parallel and radial power distribution is often used. Dynamic and high current loads are connected using a radial design, while static and low current loads can be connected in parallel. This combined

approach minimizes the drawbacks of a parallel design when a purely radial design is not feasible.

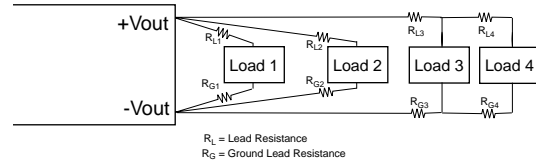

Fig.18 Mixed Power Distribution

Redundant Operation

A common requirement in high reliability systems is to provide redundant power supplies. The easiest way to do this is to place two converters in parallel, providing fault tolerance but not load sharing. Oring diodes should be used to ensure that failure of one converter will not cause failure of the second. Figure 19 shows such an arrangement. Upon application of power, one of the converters will provide a slightly higher output voltage and will support the full load demand. The second converter will see a zero load condition and will "idle". If the first converter should fail, the second converter will support the full load. When designing redundant converter circuits, Schottky diodes should be used to minimize the forward voltage drop. The voltage drop across the Schottky diodes must also be considered when determining load voltage requirements.

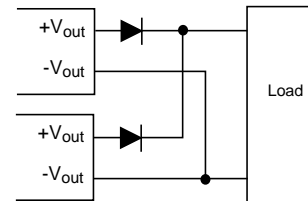

Fig.19 Redundant Operation

Thermal Management

Technologies

AVH Series 50 W to 150 W modules feature high efficiency and the 5 V output units have typical efficiency of 85% at full load. With less heat dissipation and temperature-resistant components such as ceramic capacitors, these modules exhibit good behavior during prolonged exposure to high temperatures. Maintaining the operating case temperature (T_c) within the specified range help keep internal-component temperatures within their specifications which in turn help keep MTBF from falling below the specified rating. Proper cooling of the power modules is also necessary for reliable and consistent operation.

Basic Thermal Management

Measuring the case temperature of the module (T_c) as the method shown in Figure 20 can verify the proper cooling. Figure 20 shows the metal surface of the module and the pin locations. The module should work under 90°C for the reliability of operation and T_c must not exceed 100 °C while operating in the final system configuration. The measurement can be made with a surface probe after the module has reached thermal equilibrium. If a heat sink is mounted to the case, make the measurement as close as possible to the indicated position. It makes the assumption that the final system configuration exists and can be used for a test environment.

The following text and graphs show guidelines to predict the thermal performance of the module for typical configurations that include heat sinks in natural or forced airflow environments. Note that T_c of module must always be checked in the final system configuration to verify proper

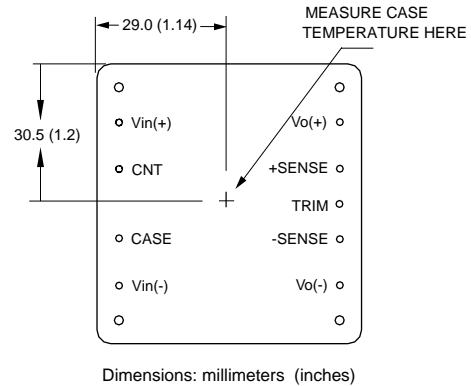

Fig.20 Base-plate Temperature Measurement

operational due to the variation in test conditions.

Thermal management acts to transfer the heat dissipated by the module to the surrounding environment. The amount of power dissipated by the module as heat (P_D) is got by the equation below:

$$P_D = P_I - P_O$$

where : P_I is input power;

P_O is output power;

P_D is dissipated power.

Also, module efficiency (η) is defined as the following equation:

$$\eta = P_O / P_I$$

If eliminating the input power term, from two above equations can yield the equation below:

$$P_D = P_O (1-\eta) / \eta$$

The module power dissipation then can be calculated through the equation.

Because each power module output voltage has a different power dissipation curve, a plot of power dissipation versus output current over three different line voltages is given in each module-specific data sheet. The typical power dissipation curve of AVH series 5V output are shown as figure 21 to figure 24.

Module Derating

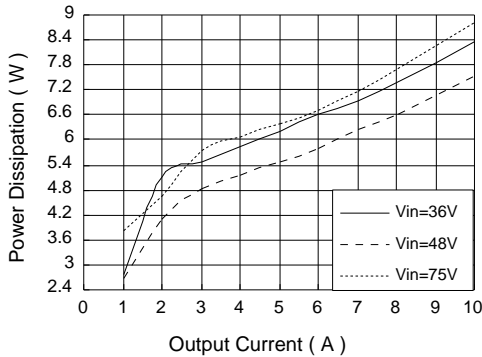

Fig.21 AVH50-48S05 Power Dissipation Curves

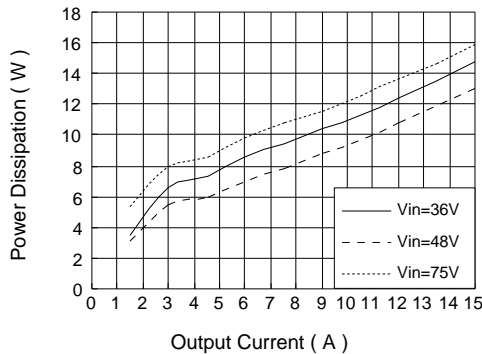

Fig.22 AVH75-48S05 Power Dissipation Curves

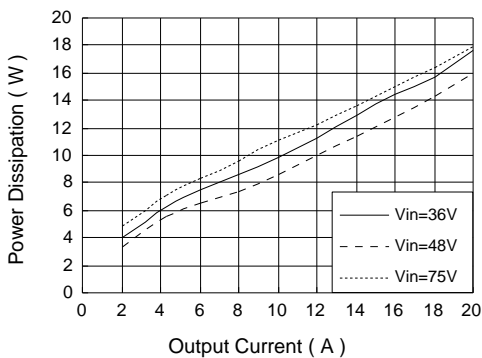

Fig.23 AVH100-48S05 Power Dissipation Curves

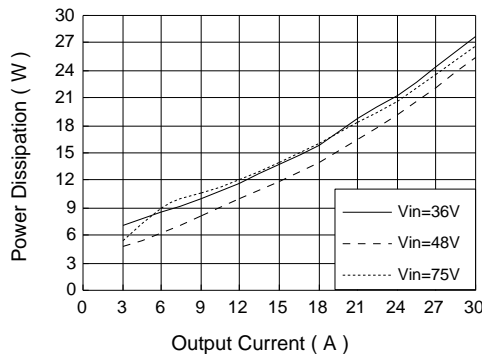

Fig.24 AVH150-48S05 Power Dissipation Curves

Experiment Setup

From the experimental set up shown in figure 25, the derating curves as figure 26 can be drawn. Note that the PWB (printed-wiring board) and the module must be mounted vertically. The passage has a rectangular cross-section. The clearance between the facing PWB and the top of the module is kept 13 mm (0.5 in.) constantly.

Convection Without Heat Sinks

Heat transfer can be enhanced by increasing the airflow over the module. Figure 26 shows the maximum power that can be dissipated by the module.

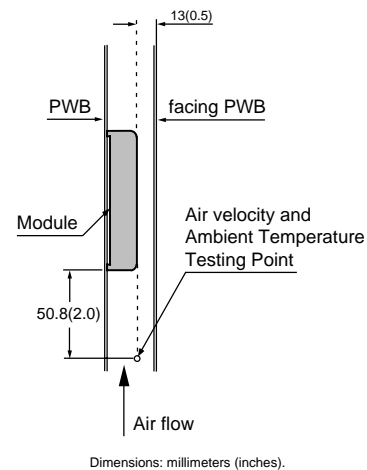

Fig.25 Experiment Set Up

In the test, natural convection airflow was measured at 0.05 m/s to 0.1 m/s (10 ft./min. to 20 ft./min.). The 0.5 m/s to 4.0 m/s (100 ft./min. to 800 ft./min.) curves are tested with externally adjustable fans. The appropriate airflow for a given operating condition can be determined through figure 26.

AVH Half-Brick Series
48V Input, 5V Single Output, 50-150W DC-DC Converter

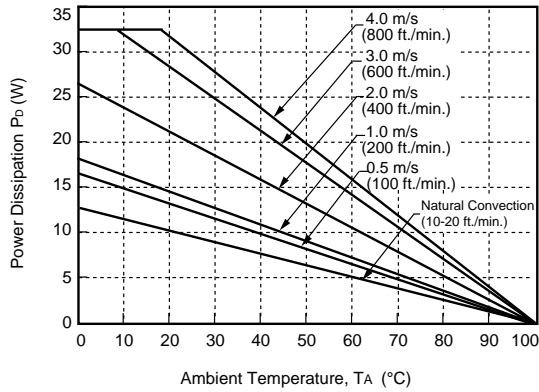

Fig.26 Forced Convection Power Derating without Heat Sink

Example 1. How to calculate the minimum airflow required to maintain a desired Tc?

If a AVH150-48S05 module operates with a 48V line voltage, a 25 A output current, and a 40 °C maximum ambient temperature, What is the minimum airflow necessary for the operating?

Determine Pd (referenced Fig.24) with condition:

$V_{in} = 48 \text{ V}$

$I_o = 25 \text{ A}$

Get: $P_D = 20 \text{ W}$

And with $T_A = 40 \text{ °C}$

Determine airflow (Fig.26):

$v = 3 \text{ m/s (600 ft./min.)}$

Example 2. How to calculate the maximum output power of a module in a certain convection and a max. TA?

What is the maximum power output for a AVH150-48S05 operating at following conditions:

$V_{in} = 48 \text{ V}$

$v = 3.0 \text{ m/s (600 ft./min.)}$

$T_A = 40 \text{ °C}$

Determine Pd (Fig.26)

$P_D = 21 \text{ W}$

Determine Io (Fig.24):

$I_o = 26 \text{ A}$

Calculate Po:

$P_o = (V_o) \times (I_o) = 5 \times 26 = 130 \text{ W}$

Although the two examples above use 100 °C as the maximum base-plate temperature, for extremely high reliability applications, one may design to a lower base-plate temperature as shown in Example 4 on page 24.

Heat Sink Configuration

Several standard heat sinks are available for the AVH 50 W to 150 W modules as shown in Figure 27 to Figure 29.

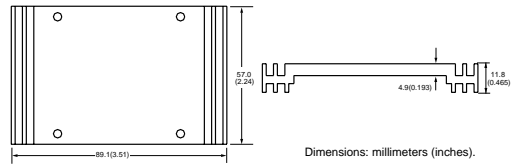

Fig.27 Non Standard Heatsink

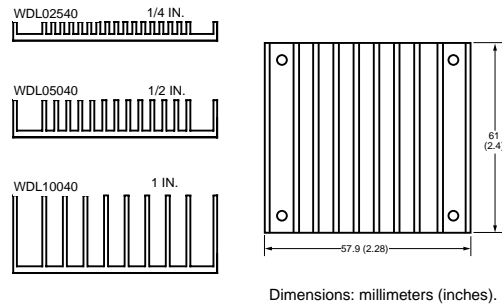

Fig.28 Longitudinal Fins Heat Sink

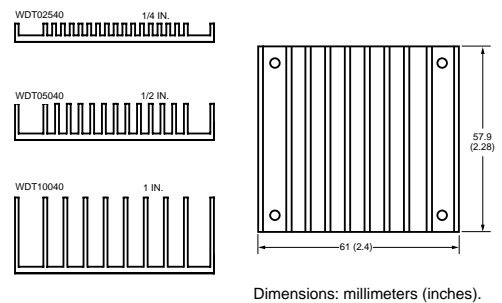

Fig.29 Transverse Fins Heat Sink

AVH Half-Brick Series
48V Input, 5V Single Output, 50-150W DC-DC Converter

The heat sinks mount to the top surface of the module with screws torqued to 0.56 N-m (5 in.-lb). A thermally conductive dry pad or thermal grease is placed between the case and the heat sink to minimize contact resistance (typically 0.1°C/W to 0.3°C/W) and temperature differential.

Nomenclature for heat sink configurations is as follows:

WDxyyy40

where:

x = fin orientation: longitudinal (L) or transverse (T)

yyy = heat sink height (in 100ths of inch)

For example, WDT5040 is a heat sink that is transverse mounted (see Figure 29) for a 61 mm x 57.9 mm (2.4 in.x 2.28 in.) module with a heat sink height of 0.5 in.

Heatsink Mounting Advice

A crucial part of the thermal design strategy is the thermal interface between the baseplate of the module and the heatsink. Inadequate measures taken here will quickly negate any other attempts to control the baseplate temperature. For example, using a conventional dry insulator can result in a case-heatsink thermal impedance of >0.5°C/W, while use one of the rec-

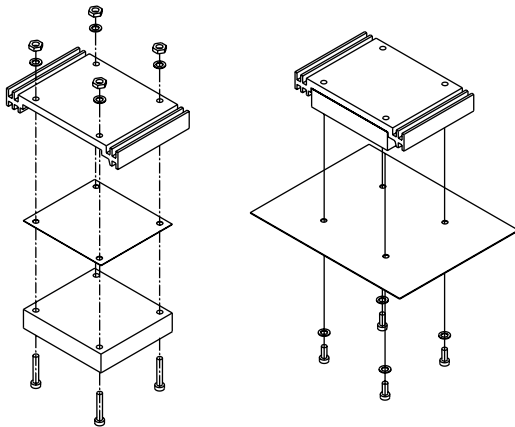

Fig.30 Heat Sink Mounting

ommended interface methods (silicon grease or thermal pads available from our company) can result in a case-heatsink thermal impedance around 0.1°C/W.

Natural Convection with Heat Sink

The power derating for a module with the heat sinks (shown as figure 27 to figure 29) in natural convection is shown in figure 31. In this test, natural convection generates airflow about 0.05 m/s to 0.1 m/s (10ft./min to 20ft./min). Figure 31 can be used for heat-sink selection in natural convection environment.

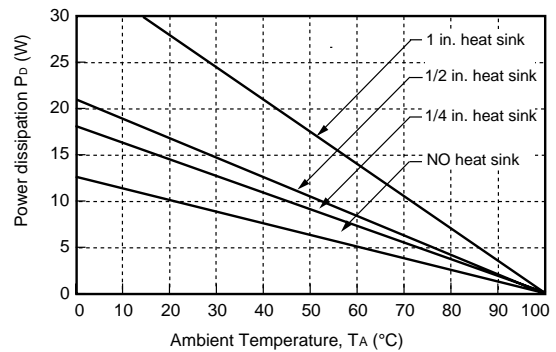

Fig.31 Heat Sink Power Derating Curves, Natural Convection

Example 3. How to select a heat sink?

What heat sink would be appropriate for a AVH150-48S05 in a natural convection environment at nominal line, 3/4 load, and maximum ambient temperature of 40°C?

Determine Pd (referenced Fig.24) with condition:

$$V_{in} = 48 \text{ V}$$

$$I_o = 3/4 (30) = 23 \text{ A}$$

$$T_A = 40 \text{ }^\circ\text{C}$$

Get: $P_D = 19 \text{ W}$

Determine Heat Sink (Fig.31):

1 in. allows up to $T_A = 45 \text{ }^\circ\text{C}$

Basic Thermal Model

There is another approach to analyze module thermal performance, to model the overall thermal resistance of the module. This presentation method is especially useful when considering heat sinks. The following equation can be used to calculate the total thermal resistance .

$$RCA = \Delta T_{C, \max} / P_D$$

Where RCA is the module thermal resistance;

$\Delta T_{C, \max}$ is the maximum base-plate temperature rise;

P_D is the module power dissipation.

In this model, P_D , $\Delta T_{C, \max}$, and RCA are equals to current flow, voltage drop, and electrical resistance, respectively, in Ohm's law, as shown in Figure 32. Also, $\Delta T_{C, \max}$ is defined as the difference between the module base-plate temperature (T_C) and the inlet ambient temperature (T_A).

$$\Delta T_{C, \max} = T_C - T_A$$

Where T_C is the module base-plate temperature; T_A is the inlet ambient temperature.

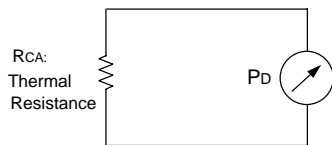

Fig.32 Basic Thermal Resistance Model

For AVH Series 50W to 150W 5V output converters, the module's thermal resistance values versus air velocity have been determined experimentally and shown in figure 33. The highest values on each curve represents the point of natural convection.

Figure 33 is used for determining thermal performance under various conditions of airflow and heat sink configurations.

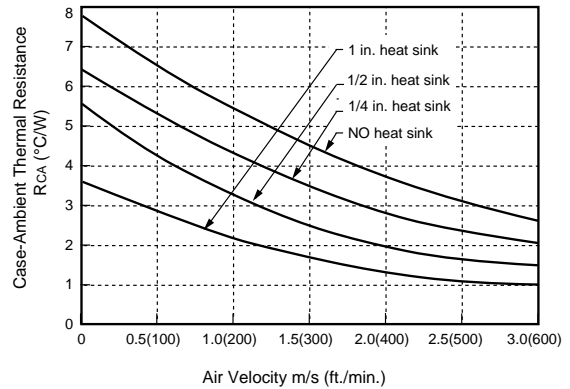

Fig.33 Case-to-Ambient Thermal Resistance Curves; Either Orientation

Example 4. How to determine the allowable minimum airflow to heat sink combinations necessary for a module under a desired T_C and a certain condition?

Although the maximum base-plate temperature for the AVH Series converters is 100°C , you can improve module reliability by limiting $T_{C, \max}$ to a lower value. How to decide? For example, what is the allowable minimum airflow for AVH150 heat sink combinations at desired T_C of 80°C ?

The working condition is as following:

$$V_{in} = 48 \text{ V}, I_o = 25 \text{ A}, T_A = 40^\circ\text{C}$$

Determine P_D (Fig.24)

$$P_D = 20 \text{ W}$$

Then solve RCA:

$$RCA = \Delta T_{C, \max} / P_D$$

$$RCA = (T_C - T_A) / P_D$$

$$RCA = (80 - 40) / 20 = 2^\circ\text{C/W}$$

determine air velocity from figure 33:

If no heat sink:

$$v > 3.0 \text{ m/s (600 ft./min.)}$$

If 1/4 in. heat sink:

$$v = 3.0 \text{ m/s (600 ft./min.)}$$

If 1/2 in. heat sink:

$$v = 2.0 \text{ m/s (400 ft./min.)}$$

If 1 in. heat sink:

$$v = 1.2 \text{ m/s (240 ft./min.)}$$

Example 5. How to determine base-plate temperature (T_c) for the various heat sink configurations at certain air velocity?

What is the allowable T_c for AVH150 heat sink configurations at desired air velocity of 2.0 m/s, and it is operating at a 48 V line voltage, a 25 A output current, a 40 °C maximum ambient temperature?

Determine P_D (Fig.24) with condition:

$$V_{in} = 48 \text{ V}$$

$$I_O = 25 \text{ A}$$

$$T_A = 40 \text{ }^\circ\text{C}$$

$$v = 2.0 \text{ m/s (400 ft./min.)}$$

Get: P_D = 20 W

Determine T_c: $T_c = (RCA \times P_D) + T_A$

Determine the corresponding thermal resistances (RCA) from Figure 33:

No heat sink: RCA = 3.8 °C/W

$$T_c = (3.8 \times 20) + 40 = 116 \text{ }^\circ\text{C}$$

1/4 in. heat sink: RCA = 2.8 °C/W

$$T_c = (2.8 \times 20) + 40 = 96 \text{ }^\circ\text{C}$$

1/2 in. heat sink: RCA = 2.0 °C/W

$$T_c = (2.0 \times 20) + 40 = 80 \text{ }^\circ\text{C}$$

1 in. heat sink: RCA = 1.2 °C/W

$$T_c = (1.2 \times 20) + 40 = 64 \text{ }^\circ\text{C}$$

In this configuration, the heat sink would have to be at least 1/4 in. high so that the power module does not exceed the maximum base-plate temperature of 100°C.

Mechanical Considerations

Installation

Although AVH series converters can be mounted in any orientation, free air-flowing must be taken. Normally power components are always put at the end of the airflow path or have the separate airflow paths. This can keep other

system equipment cooler and increase component life spans.

Soldering

AVH series converters are compatible with standard wave soldering techniques. When wave soldering, the converter pins should be preheated for 20-30 seconds at 110°C, and wave soldered at 260°C for less than 10 seconds.

When hand soldering, the iron temperature should be maintained at 425°C and applied to the converter pins for less than 5 seconds. Longer exposure can cause internal damage to the converter. Cleaning can be performed with cleaning solvent IPA or with water.

MTBF

The MTBF, calculated in accordance with Bellcore TR-NWT-000332 is 2,000,000 hours. Obtaining this MTBF in practice is entirely possible. If the ambient air temperature is expected to exceed +25°C, then we also advise a heatsink on the AVH, oriented for the best possible cooling in the air stream.

Emerson Network Power Co., Ltd can supply replacements for converters from other manufacturers, or offer custom solutions. Please contact the company for details.

-----This manual is subject to be changed or updated without notification. The up-to-date manuals are available in our company website. -----

AVH Half-Brick Series
48V Input, 5V Single Output, 50-150W DC-DC Converter

Mechanical Chart

Recommended hole pattern:

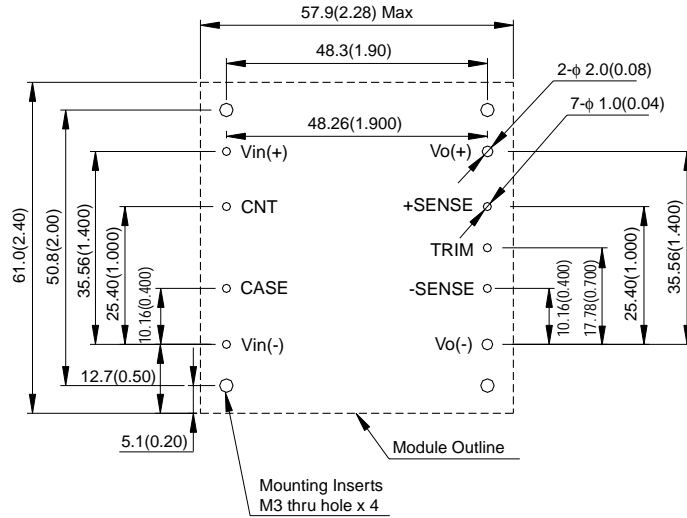

Mechanical size:

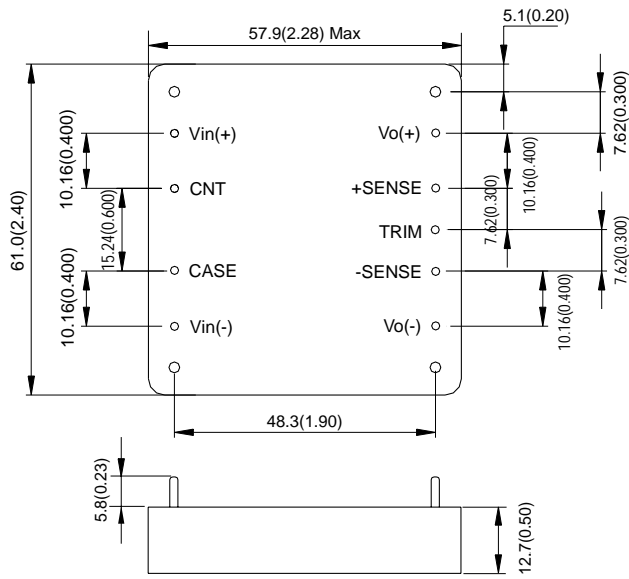

Unit: mm(inch)

Pin Length Option	Device Code Suffix
4.80mm ± 0.5mm 0.189in. ± 0.020in.	-4
3.80mm ± 0.25mm 0.150in. ± 0.010in.	-6
2.80mm ± 0.25mm 0.110in. ± 0.010in.	-8
5.8mm ± 0.5mm 0.228in. ± 0.02in.	none

Base-plate side view

Tolerances:
 Inches Millimeters
 .xx ±0.020 .x ±0.5
 .xxx ±0.010 .xx ±0.25

Pin length:
 >4mm ±0.02inch (±0.5mm)
 <4mm ±0.01inch (±0.25mm)